

## *Kataspinifera baumannii*: a new genus and species of deep photic coccolithophores resembling the non-calcifying haptophyte *Chrysochromulina*

HARALD ANDRULEIT<sup>1</sup> & JEREMY R. YOUNG<sup>2,\*</sup>

<sup>1</sup>Bundesanstalt für Geowissenschaften und Rohstoffe (Federal Institute for Geosciences and Natural Resources), Postfach 510153, 30631 Hannover, Germany

<sup>2</sup>Palaeontology Department, The Natural History Museum, London SW7 5BD, UK

\*Corresponding author (e-mail: j.young@nhm.ac.uk)

**ABSTRACT** – An unusual new coccolithophore species is described from the deep photic zone. The species is dimorphic with small body coccoliths bearing short spines and larger spine-coccoliths with exceptionally long, hollow, quadrate spines. The species is rare but has been observed in the Pacific, Indian and Atlantic Oceans reinforcing other evidence that the deep photic zone nanoflora is more diverse and heterogeneous than previously assumed.

The species also shows remarkable morphological similarity to some species of the non-calcifying haptophyte *Chrysochromulina* of a type which has frequently been cited as evidence for possible multiple origins of calcification in haptophytes. However, the coccolith structure strongly indicates that the species is a member of the Papposphaeraceae. Available phylogenetic data from molecular genetics and biomineralization modes make it extremely unlikely that the Papposphaeraceae are closely related to the spine-bearing *Chrysochromulina* species and so the striking morphological similarity is almost certainly a case of homoeomorphy, and possibly functional convergence. *J. Micropalaeontol.* 29(2): 135–147, December 2010.

**KEYWORDS:** *coccolithophores, phytoplankton taxonomy, living, deep-photoc*

### INTRODUCTION

Recent research has advanced the taxonomy of extant coccolithophores significantly and their taxonomy is probably better established than that of any other phytoplankton group. None the less new taxa continue to be recorded, especially from the deep-photoc zone (Jordan *et al.*, 1991; Jordan & Chamberlain, 1993; Hagino & Okada, 1998; Cros & Fortuño, 2002; Young *et al.*, 2003; Aubry & Kahn, 2006; Bollmann *et al.*, 2006; Young & Andruleit, 2006; Young, 2008). The occurrence of rare morphologically disparate coccolithophores appears to be a feature of the deep photic zone and so these species need to be described. Another unusual new coccolithophore species was found during examination of samples from the SE Pacific Ocean off Chile and from the South Atlantic. The only previously published record of the species was a single specimen from the Alboran Sea, western Mediterranean (Young *et al.*, 2003). A few other unpublished occurrences are, however, known to us from the South Atlantic (Adey, pers comm.), Pacific (Young, unpublished observations) and the eastern Indian Ocean (Andruleit, unpublished data). The present study is based primarily on the rare but regular occurrence of this species in the SE Pacific Ocean off Chile. The ecological distribution and taxonomic affinities of the new species are described and discussed. This is worth doing in some depth since there has been much speculation on the relationships of calcifying and non-calcifying haptophytes (e.g. Manton & Sutherland, 1975; Janin, 1995; de Vargas *et al.*, 2007) and of modern and fossil coccoliths (e.g. Norris, 1983; Bown *et al.*, 2008), but there have been few careful evaluations of the available data. The superficial similarities of the new species to multiple modern and fossil taxa makes it an ideal exemplar for rational analysis of affinities.

### MATERIAL AND METHODS

The samples used as type material were collected during a geological cruise, So161, of the R/V *Somme* in the Eastern Pacific

during December–January 2001/2002 (Wiedicke *et al.*, 2002). Samples were collected at eleven stations west of Chile between 36 and 40°S (Fig. 1). At each station depth transects of six samples were collected using a rosette sampler with attached CTD (conductivity temperature device) device for monitoring salinity, temperature, oxygen and depth (Fig. 2). Nutrient and chlorophyll data were not collected on this cruise. Sample depths were varied based on the temperature data in order to ensure good sampling, especially of the thermocline population. For each sample one to two litres of seawater were filtered onto fleece-supported regenerated cellulose filters (Sartorius<sup>®</sup>, 50 mm diameter, 0.45 µm pore diameter). The samples were investigated using a field emission scanning electron microscope (SEM; FEI Sirion 200) with more than 300 specimens being identified and counted per filter; except in the deepest samples, where a smaller number was counted due to the scarcity of coccospheres. In total 10 coccospheres of the new species were found during the routine counts. Selected filters on which the new species was more common were then re-examined in order to obtain high resolution images, a further 14 specimens were found during this examination. Measurements on the digital images were made using the software program Scandium (Soft Imaging System GmbH). The descriptive terminology used here follows the recommendations of Young *et al.* (1997).

### SYSTEMATIC DESCRIPTION

Division **Haptophyta** Hibberd, 1972

Class **Prymnesiophyceae** Hibberd, 1976

Family **Papposphaeraceae** Jordan & Young, 1990, emend

**Diagnosis.** Coccolithophores bearing narrow-rimmed murolith coccoliths. Rim has form of a narrow slightly flaring wall formed of laths of two alternating types. One lath type relatively

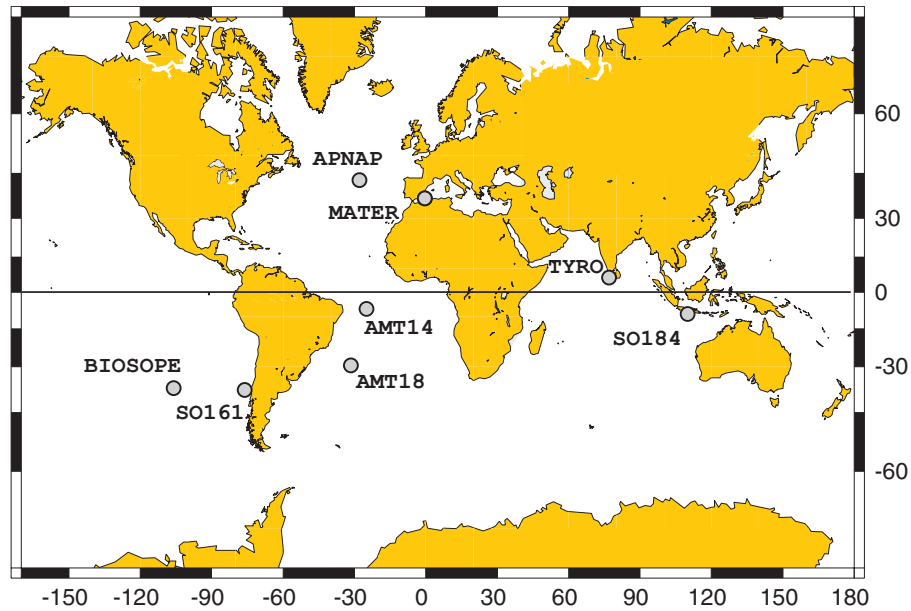

Fig. 1. Map of localities where *Kataspinifera* was observed.

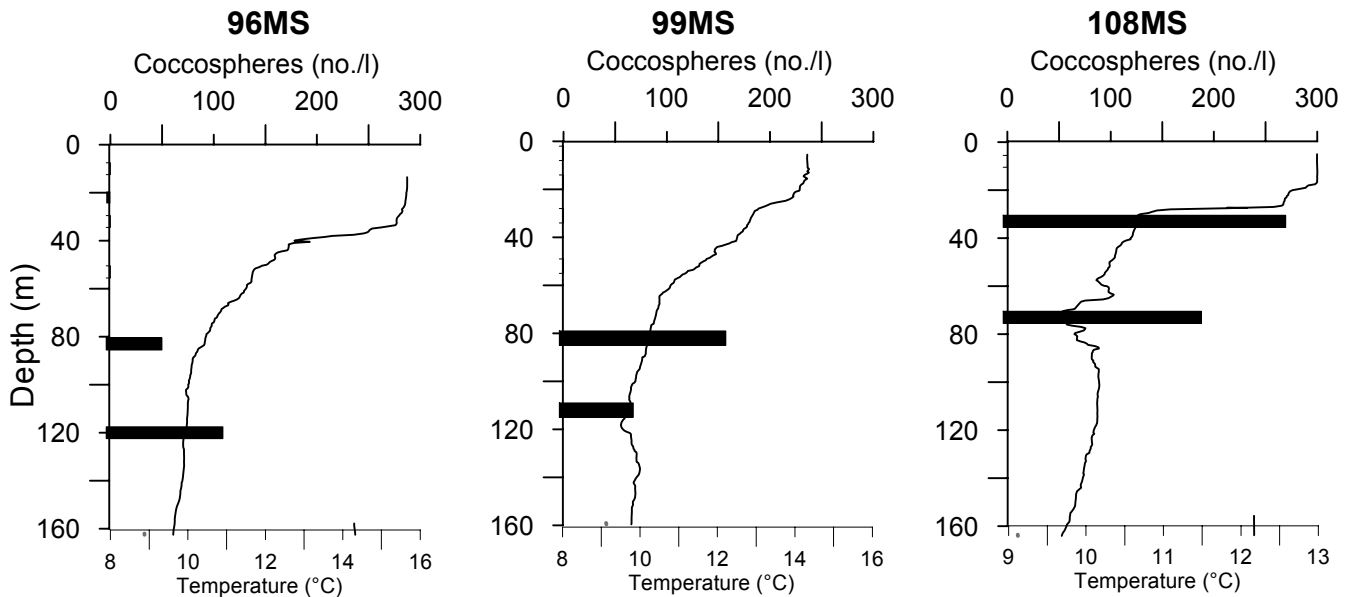

Fig. 2. Sample depths and temperature profiles for the sites from cruise So161, at which *Kataspinifera* was quantitatively recorded. Horizontal bars indicate calculated abundances of *Kataspinifera* in the samples. Locations: 96MS 39°50'S, 74°55'W; 99MS 39°50'S, 74°30'W; 108MS 38°21'S, 74°55'W (Janin, 1995).

small, confined to the proximal part of the wall, the other vertically expanded. Central area usually spanned by a central cross, hollow quadrate central process often present.

**Genera included.** *Papposphaera*, *Pappomonas*, *Picarola*, *Pocillithus*, *Kataspinifera* and *Vexillarius*. Note: as discussed below, the diagnosis and circumscription of the Papposphaeraceae is broadened here.

*Kataspinifera* gen nov. Andruleit & Young

**Type species.** *Kataspinifera baumannii*

**Diagnosis.** Coccolithophore with dimorphic coccosphere formed of circular to elliptical muralith body coccoliths and spine coccoliths with flaring rims and long, hollow, quadrate spines, supported by a central cross.

**Latin diagnosis.** Cellula coccolithophora cum coccosphaera dimorpha composita ab muralithis coccolithis corporis circularibus versus ellipticos et coccolithis spiniferis cum marginibus amplificatis et spinis longis excavatis quadratis, suffultis ab cruce centrali.

**Derivation of name.** From the Greek *κατα* (down) referring to the deep photic zone habitat of the species and *spinifera* (latin)

spine-bearing referring to the dominant morphological character of the genus.

*Kataspinifera baumannii* sp. nov. Andrleit & Young

**Diagnosis.** Species of *Kataspinifera* with coccosphere composed of c. 50–70 circular to elliptical body coccoliths with a diagonally orientated central-cross, and 6–9 larger spine coccoliths with a very long quadrate central spine supported by a central cross.

**Latin diagnosis.** Species *Kataspinifera* cum coccosphaera composita ab circa 50–70 coccolithis corporis circularibus versus ellipticos cum cruce centrali diagonaliter directo, et 6–9 coccolithis spiniferis majoribus cum spina centrali longissima quadrata suffulta ab cruce centrali.

**Derivation of name.** From the distinguished coccolithophore specialist Karl-Heinz Baumann (University of Bremen), in recognition of his scientific contributions, especially in the field of extant coccolithophore research.

**Type specimen.** Specimen illustrated in BGR SEMs 6253, 6254 (Pl. 1, figs A–B). This specimen is located on BGR coccolithophore collection SEM stub 3974.

**Type sample.** So161-5, 108MS 33m, collected from eastern Pacific Ocean off Chile, Lat. 38°20'45" S Long. 74°09'47" W, 20 January 2002 by BGR.

**Type depository.** Type images and stub are archived in the BGR (Bundesanstalt für Geowissenschaften und Rohstoffe) coccolithophore collection.

**Description – coccospheres.** This new species is characterized by a minute cell body and very long spines (Pl. 1). It is only lightly calcified and thus very delicate. All observed coccospheres are collapsed so the original shape cannot be determined with certainty; however, the scatters are not consistently elongated and often are circular to subcircular. So, we infer that the original coccospheres were spherical or sub-spherical in shape, similar to *Acanthoica quattrosipina* Lohmann. The diameter of 12 relatively coherent collapsed coccospheres ranged from 4.5 to 6.9  $\mu\text{m}$  (mean 5.4  $\mu\text{m}$ ). (Note: only scatters that could be assigned to a clearly defined area were measured, so the original coccosphere diameter would have been about the same size, or slightly smaller.)

The coccospheres are dimorphic with circular to elliptical body coccoliths and spine coccoliths with elevated rims and long spines (Pl. 1). The body coccoliths are very delicate and are often found deformed or broken, so their shape is not always easy to determine. None the less all coccospheres we have observed contain both weakly elliptical and circular coccoliths, more or less randomly distributed across the coccosphere. The number of body coccoliths ranges from 29 to 42 (counts on nine specimens). This suggests that the coccospheres contain 50–70 body coccoliths, on the assumption that slightly over half the coccoliths on a collapsed coccosphere are visible. The spine coccoliths appear to be clustered at opposite sides of the

coccosphere with 3–5 at each pole. There is no apparent differentiation between the spine coccoliths at the two poles in terms of either number of coccoliths or coccolith morphology. The total number of spine coccoliths ranges from 6 to 9.

The coccoliths seem to be only loosely attached to the coccosphere which evidently disintegrates as the cell is flattened on the filter surface. The arrangement of the coccoliths appears to be non-overlapping and non-interlocking. Often coccoliths are obscured, probably as a result of the cell membrane and other organics from the cell coating the coccoliths. No evidence of flagella or a haptonema has been seen, but this is not necessarily significant, since they are only occasionally visible in SEMs of coccolithophores.

**Description – body coccoliths.** The body coccoliths have a narrow circular to elliptical rim, a diagonally orientated central-cross formed of narrow bars and a slender central spine (Fig. 3). The coccoliths show fairly consistent lengths, ranging from 1.2 to 1.8  $\mu\text{m}$ ; mean 1.4  $\mu\text{m}$ , standard deviation 0.17  $\mu\text{m}$ ,  $n = 55$ . They vary rather more in width, from 0.83 to 1.8  $\mu\text{m}$ ; mean 1.2  $\mu\text{m}$ , standard deviation 0.23  $\mu\text{m}$ ,  $n = 55$ , so that both nearly circular and rather strongly elliptical varieties occur but with a continuous range of intermediates. The average number of rim elements is about 20, with higher numbers on larger coccoliths.

In distal view the rim appears to consist of a single cycle of elongate elements with radial sutures. These rim elements are simple quadrate bars, with no apparent flange or shield development. In proximal view additional, very small, peg-like elements can be seen between each pair of larger rim elements (Pl. 1, fig. D).

Each bar of the cross is primarily formed from a single long, lath-shaped, element, whilst the spine is formed of a vertically directed quadrate element. At the base of the spine a few short inclined elements connect the spine and the cross-bars. The spine has a mean height of 0.66  $\mu\text{m}$  ( $n = 20$ ).

**Description – spine coccoliths.** These are circular muroliths with, a thin flaring rim, a central cross and a very long central spine. The coccolith diameter ranges from 1.7 to 2.6  $\mu\text{m}$  with a mean of 2.2  $\mu\text{m}$  ( $n = 24$ ).

The rim is formed of at least two cycles of elements. The main part of the rim is formed of a regular cycle of thin abutting plates with vertical sutures. A second smaller cycle of elements occurs at the base of the rim. This basal cycle is most clearly visible in views of the inner side of the rim and on specimens in which the rim has collapsed (e.g. Pl. 2, figs A, C). It consists of a similar number of elements to the wall cycle but they are offset by half an element. On the outside of the rim a cycle of peg-like elements occurs at the base of the wall, these are probably extensions from the basal cycle.

The basal cycle elements are similar in size and shape to the rim elements of the body coccoliths, so it is possible that they are homologous to them, with the wall elements being extended equivalents of the peg-like elements of the body coccoliths.

The central cross is constructed in the same way as in the body coccoliths but is more robust and seems to have a slight anticlockwise offset of the cross bars. The central area appears to be slightly concave (e.g. Pl. 1, fig. F) and is often covered by a thin organic sheet which probably is the baseplate-scale (e.g.

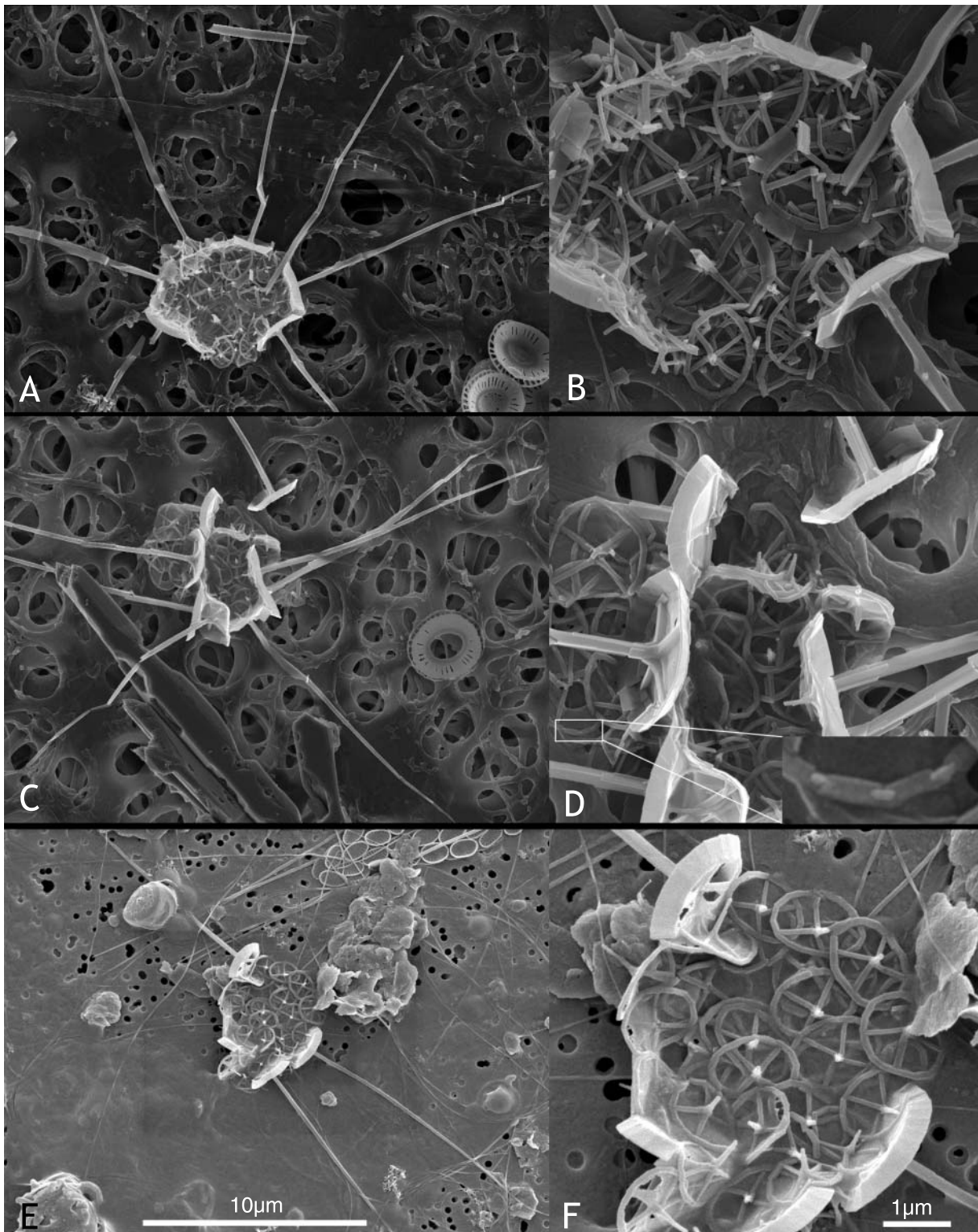

**Explanation of Plate 1.**

SEM images of three collapsed coccospheres of *Katspinifera baumannii* n. sp. Left-hand images show the entire coccosphere; right-hand images detail the main body of the coccosphere. Scale bars apply to whole column of images. **A, B.** Holotype specimen from the eastern Pacific west of Chile. Complete collapsed coccosphere. Images BGR6253 and 6254. **C, D.** Second specimen from an adjacent station of the type sample. Images BGR6314 and 6315. Inset detail of rim of body coccolith. **E, F.** Specimen from the Alboran Sea. Images NHM193-83 and 193-82.

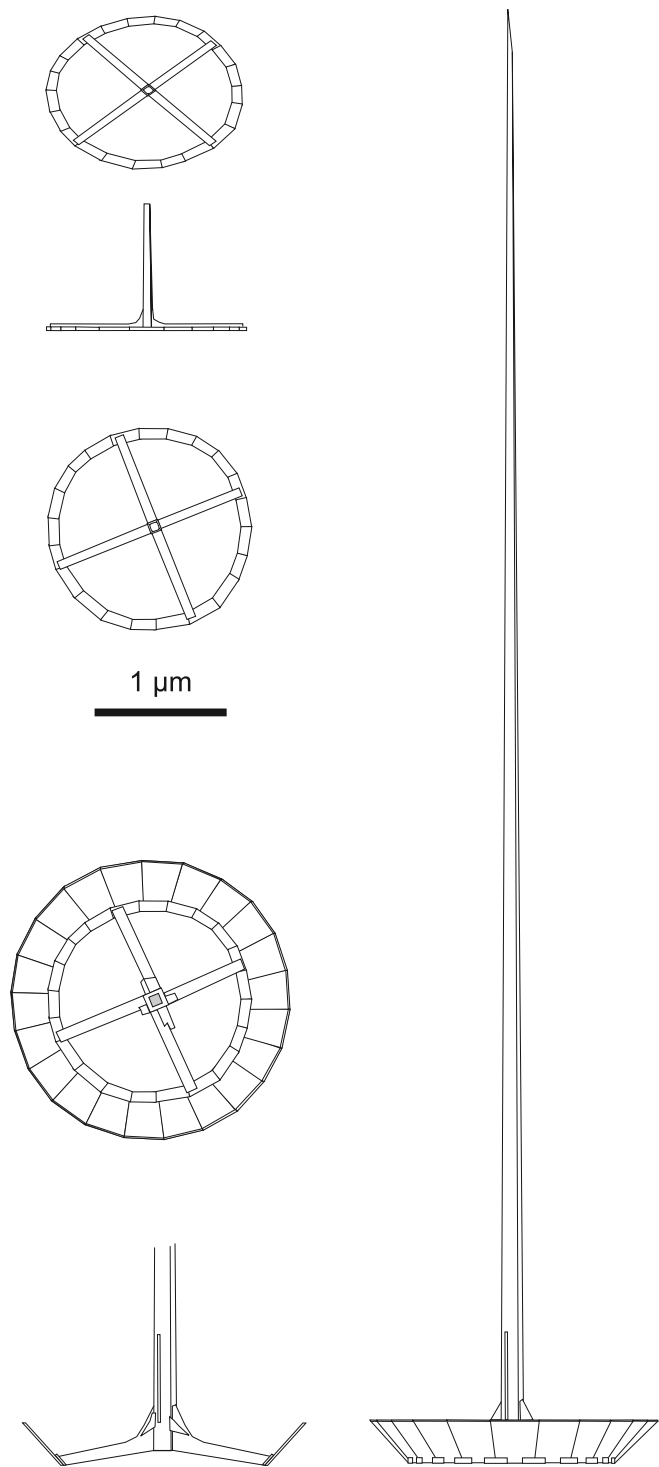

**Fig. 3.** Schematic drawings of the different *Kataspinifera* coccolith morphologies: spine coccoliths (bottom row, left and right) and circular and elliptical variants of body coccoliths (top left above scale bar) in plan and side views.

Pl. 1, fig. D). However, we could not detect any trace of a microfibrillar structure to these sheets even though the resolution of our SEM micrographs is adequate to image them if present.

The spine is square in cross-section and hollow. At the base of the spine several small elements can often be observed. In the main part of the spine, however, no sutures could be observed crossing the spine and it appears possible that the spines are almost entirely formed of four elongate lath-shaped elements arranged edge to edge. The spine tapers very gradually and can be up to 18 µm long (mean 12 µm,  $n = 20$ ), which is remarkably long in comparison to the coccosphere diameter (about 5.4 µm).

## Discussion

### Ecology

In the SE Pacific off Chile specimens of *Kataspinifera* were found in 5 of the 11 sites sampled and in a total of 8 samples (out of 65). All the sites contained coccolithophore communities with low diversities and surface assemblages dominated by *Emiliana huxleyi* (Lohmann). Probably due to the low temperatures there was no typical deep photic zone community. *Florisphaera profunda* Okada & Honjo occurred only sporadically and other typical deep photic species, such as *Oolithotus* spp. and *Gladiolithus flabellatus* Halldal & Markali were missing. So even at greater water depths *E. huxleyi* dominated the impoverished communities. In addition, species of the genera *Papposphaera* and *Pappomonas* occurred at low cell numbers but with several species present. The thermocline was rather shallow with depths between 20 m and 40 m and characterized by temperatures dropping from the surface values of 13–16°C to deep values of 9–11°C, which is a small difference compared to temperature gradients in the tropics. The samples containing the new species came from water samples ranging in temperature from 9.7–10.5°C. Salinity changes are minor but somewhat more complex and do not mirror the thermocline in the same way as temperature changes. Samples with *Kataspinifera* had salinities of 33.94 to 34.19 PSU. Maximum values of the oxygen concentration (up to 3.5 ml l<sup>-1</sup>), indicative for highest phytoplankton growth, were found below the thermocline. In contrast, highest coccolithophore numbers occurred in shallow depths above the thermocline. The new species was found exclusively below the thermocline at depths varying from 33 m to 112 m characterized by low total coccolithophore concentrations. Hence we can infer that this is a true deep-photoc species. Cell numbers were very low, reaching no more than 270 specimens per litre seawater at maximum.

We have observed additional specimens in samples from several other localities.

1. Western Mediterranean, Alboran Sea, MATER II cruise September 1999, sample 69-11 from, 37°N 0.4°W, 42.5 m in the deep chlorophyll maximum with a diverse mid-photoc coccolithophore assemblage including a range of Papposphaeraceae and Syracosphaeraceae. (Note: a specimen from this sample was illustrated in Young *et al.* (2003) as 'undescribed heterococcolithophore A'.)
2. South Atlantic, AMT cruise 14, CTD 39, 7°S 25°W, 130–140 m. Deep photic sample with diverse coccolithophore assemblage including common *Syracosphaera anthos* (Lohmann), *S. nana* (Kamptner), *Ophiaster formosus* Gran, *Emiliana huxleyi*, *Florisphaera profunda* (common but not dominant). Observed by Tim Adey, University of Southampton (pers.

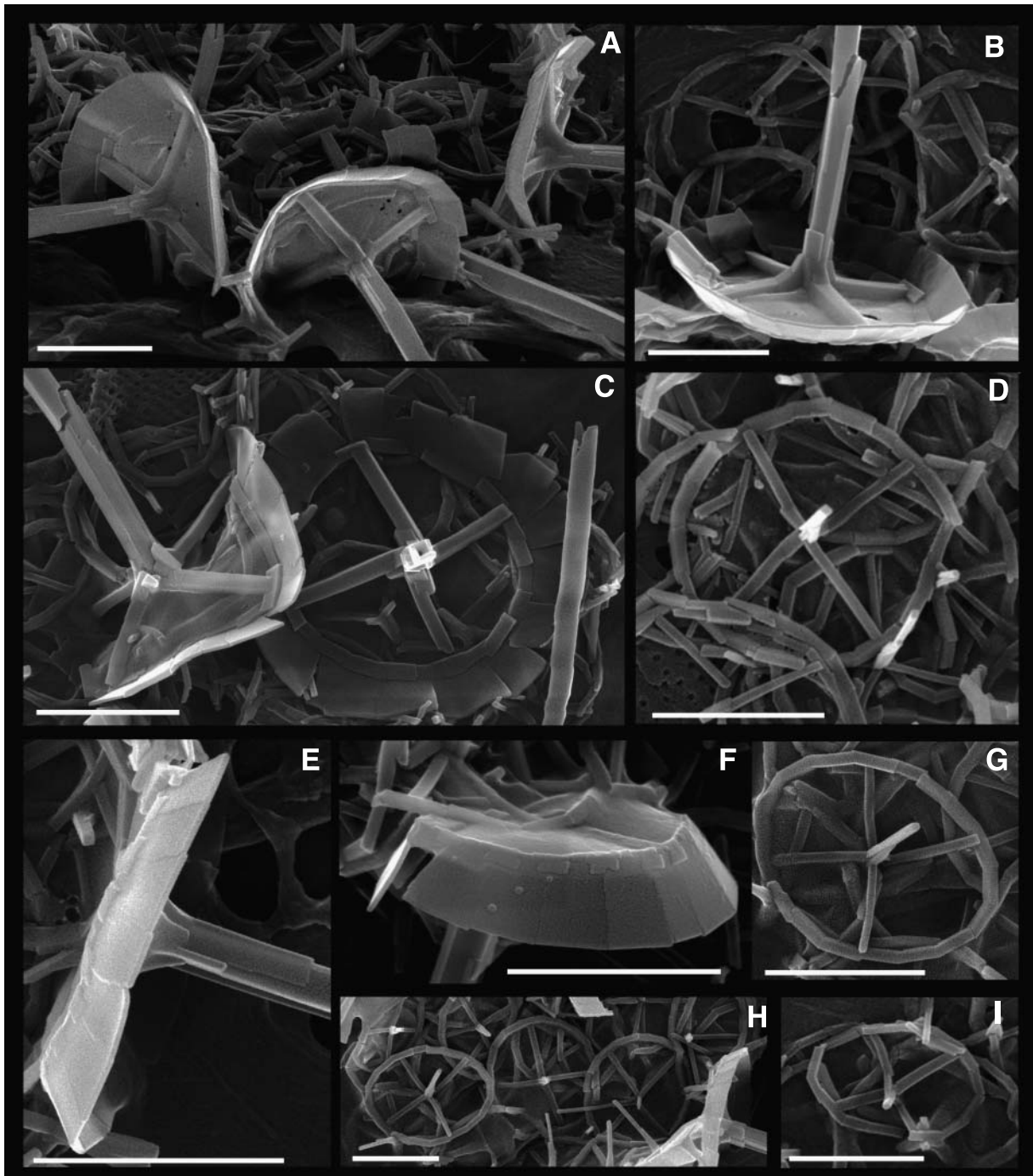

#### Explanation of Plate 2.

*Katspinifera baumannii*. Details of cocoliths; spine cocoliths and body cocoliths. All scale bars 1  $\mu\text{m}$ . **A.** Three spine cocoliths in oblique view. Image BGR6257. **B.** Side view of spine cocolith and proximal view of body cocoliths. Image BGR6315. **C.** Spine cocoliths in side and distal view. Note square cross-section of spine. Image BGR6168. **D.** Circular body cocolith in distal view. Image BGR5877. **E.** Side view of base of spine cocolith. Image BGR6259. **F.** Oblique proximal view of spine cocolith. Note proximal cycle of elements. Image BGR6152. **G.** Elliptical body cocolith in distal view. Image BGR6877. **H.** Scatter of body cocoliths. Circular body cocolith in distal view. Image BGR6282. **I.** Elliptical body cocolith in distal view. Image BGR6246.

comm.), identification confirmed by JRY. Also 1 specimen in AMT cruise 18, CTD 89, 108 m, 32.2°S, 29.8°W, November 2008 (our observations).

3. South Pacific – BIOSOPE Cruise, 32.68°S, 84.07°W, November 2004, CTD 184, depth 105 m. Two speci-

mens found in a low abundance sample dominated by *Rhabdosphaera xiphos* (Deflandre & Fert) and *Palusphaera vandellii* Lecal – specimens examined by JRY.

4. Eastern Indian Ocean offshore Java, RV *Sonne* cruise SO184 August 2005. Preliminary results suggest a more common

CALCIHAPTOPHYTE CLADE

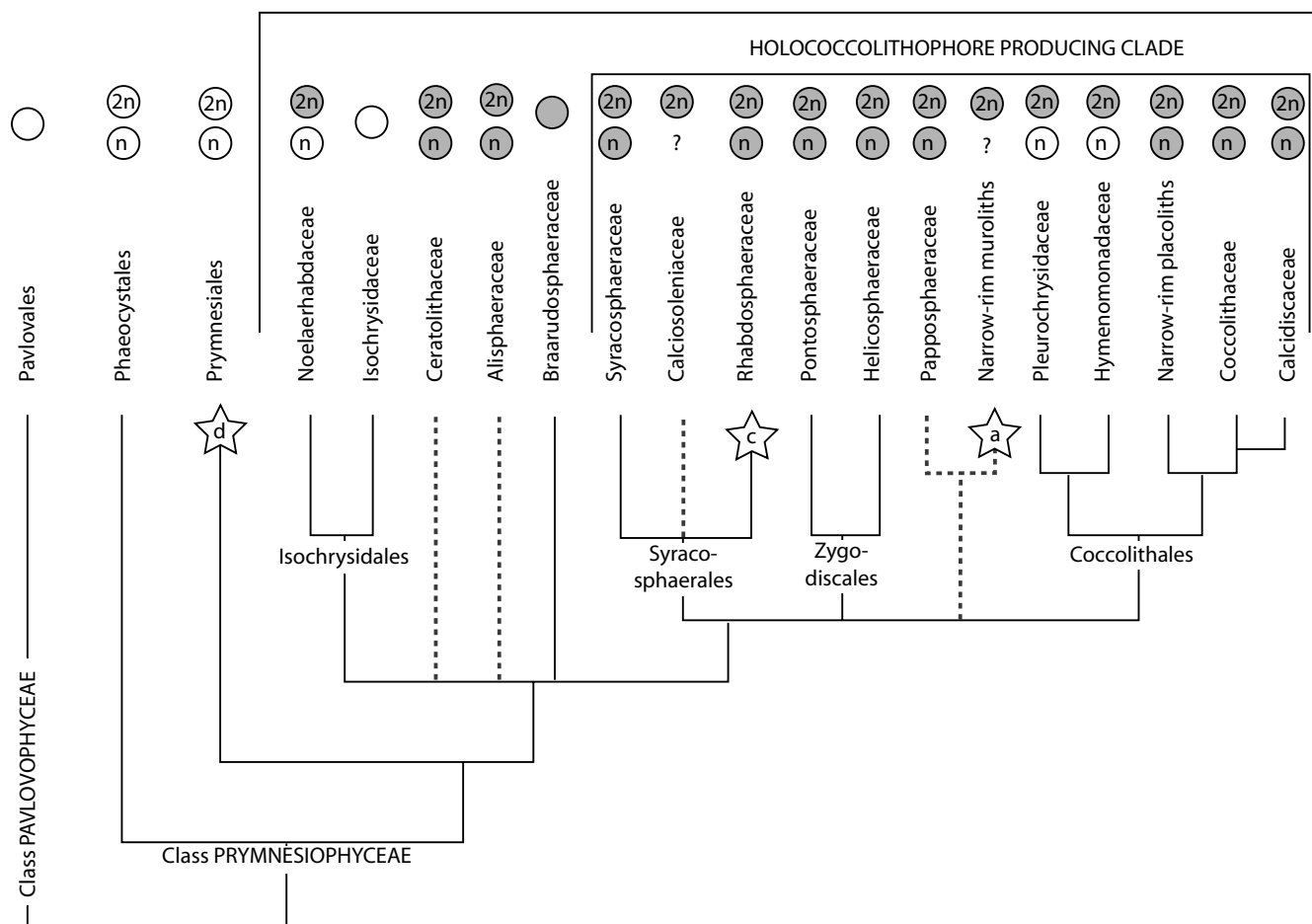

**Fig. 4.** Schematic consensus phylogeny of the haptophyta, with alternative interpretations of *Kataspinifera* n. gen indicated. Solid lines indicate relationships based on molecular genetic data, dashed lines relationships inferred from morphological data, see Young *et al.* (2005) for discussion and references; Braarudosphaeraceae placement based on Takano *et al.* (2006). Stars indicate alternative interpretations of *Kataspinifera*, as discussed in the text. Circle symbols along the top indicate if likely haploid (n) and/or diploid (2n) life cycle phases have been observed and shading indicates which phases calcify.

occurrence (> 25 specimens found, during examination by HA), in several samples with diverse deep photic zone assemblages. Species with high abundances include *Gephyrocapsa oceanica* Kamptner, *Florisphaera profunda* and *Ophiaster formosus* but other deep photic species, such as *Solisphaera* spp. and *Navilithus altivelum* Young & Andrulleit also occur.

5. North Atlantic, APNAP cruise, 42°N 26°W, October 1986, one specimen at 50 m and one at 75 m (A. Kleijne, pers. comm.).
6. Indian Ocean Tyro Cruise Gx (Snellius-II) expedition, one specimen in a sample from east of Sri Lanka, 6°N 79°E, 25 June 1985, surface (0–5 m) water in an upwelling zone (A. Kleijne, pers. comm.).

This is still a low number of specimens but with examples from the Pacific, Indian and Atlantic Oceans this is clearly a globally distributed deep photic species. The single specimen found in surface waters was from an upwelling region and is probably a case of displacement of a deep photic taxon into surface water. It also seems to show a pattern of occurring in

deep photic samples with diverse assemblages, rather than those dominated by *F. profunda*. Given the number of specimens we have observed it is rather surprising that other workers have not illustrated specimens, particularly since there have been several studies of deep photic coccolithophores by taxonomically interested workers (e.g. Okada & Honjo, 1973; Okada & McIntyre, 1979; Hagino *et al.*, 2000; Cortés *et al.*, 2001; Cros & Fortuño, 2002; Andrulleit *et al.*, 2005). A possible explanation is that other workers have observed this species but did not recognize it as a coccolithophore since it closely resembles some *Chrysochromulina* species, as discussed below.

**Taxonomic affinity**

This species does not show the diagnostic features of any previously described genus, so a new genus is clearly warranted. Various possible affinities of this genus are worth discussing, and the main ones are indicated on Figure 4. First it shows distinct similarities with the extant Papposphaeraceae, as briefly noted by Young *et al.* (2003); second, to any palaeontologist it bears a strong apparent similarity with some extinct Mesozoic

coccoliths, notably *Prediscosphaera*; third, the presence of long spines suggests possible affinities with the Rhabdosphaeraceae; fourth, it shows remarkable similarities with some species of the non-calcifying haptophyte *Chrysochromulina*.

1. *Papposphaeraceae*. The Papposphaeraceae is a relatively poorly known family of coccolithophores comprising the genera *Papposphaera* and *Pappomonas* and including many very small species best known from studies using transmission electron microscopy, such as Manton & Sutherland (1975), Manton & Oates (1975), Manton *et al.* (1976), Tangen (1972) and Thomsen *et al.* (1988). They have also been observed in the SEM by, for instance, Cros & Fortuño (2002) and Young *et al.* (2003). At high latitudes species have been recorded in the surface waters (e.g. Manton & Oates, 1975, Thomsen *et al.*, 1988) but at lower latitudes they are predominantly deep photic, with a very patchy distribution (Cortés, 1998; our observations). Typical Papposphaeraceae coccoliths are low-rimmed muroliths with an axial cross and a hollow quadrate spine, often supporting an elaborate calyx. *Papposphaera* is monomorphic, with all coccoliths bearing spines, whereas *Pappomonas* is dimorphic with spines only on some coccoliths. A highly characteristic feature of *Pappomonas* and *Papposphaera* is that the main rim elements are terminated by prominent crystal faces giving the crest of the rim a serrated profile (Pl. 3, fig. B).

Young *et al.* (2003) figured *Kataspiniifera baumannii* as an ‘undescribed dimorphic genus and species’ and included it in a group of narrow-rimmed muroliths with possible affinity to the Papposphaeraceae. The other genera included in this group were *Picarola* and *Vexillarius*, two rare deep-photoc genera described respectively by Cros & Estrada (2004) and Jordan & Chamberlain (1993) and, more tentatively, *Wigwamma*. More recently, Dunkley-Jones *et al.* (2009) have described a possible fossil member of this group, *Pocillithus*, from exceptionally well-preserved Eocene sediments from Tanzania. This grouping was based on the basic morphology, i.e. these genera and the Papposphaeraceae share simple narrow sub-vertical rims and complex disjunct central structures, although only *Pappomonas* and *Papposphaera* show the serrated rim profile. Our new observations on *Kataspiniifera* allow this suggested affinity to be analysed more carefully. To support this we present new high-resolution images of *Papposphaera lepida* Tangen and *Picarola margalefi* Cros & Estrada (Pl. 3, figs A–D). We also include for discussion images of *Vexillarius* and *Pocillithus* (Pl. 3, figs E–H).

As summarized in Table 1, five characteristics of these genera can be identified.

- i Rim morphology. All the coccoliths have simple narrow murolith rims, i.e. they have a narrow sub-vertical outer wall without flanges. In *Pappomonas* and *Papposphaera* the rim has a serrated upper margin whilst it is smooth in the other species.
- ii Rim structure. Typically the majority of the rim is formed of a single cycle of directly abutting elements with sub-vertical sutures. In addition a second cycle of elements occurs proximally, with one of these interposed elements between each of the larger elements. This structure is well documented in the Papposphaeraceae (Norris, 1983; Pl. 3, fig. B) and also occurs in the spine coccoliths of *Kataspiniifera* (Pl. 2, figs E–F) and

*Picarola* (Pl. 3, fig. D). High-resolution SEMs of *Vexillarius* are not available but in the images of Jordan & Chamberlain (1993) evidence of such a structure can be discerned. The fossil genus *Pocillithus* also shows evidence of this structure (Pl. 3, figs F–H; reproduced from Dunkley-Jones *et al.*, 2009). The body coccoliths of *Kataspiniifera* have rims which are simple hoops rather than muroliths, and the second cycle of elements is confined to the proximal surface; however, this structure can easily be a reduced version of the typical structure.

- iii Central area structure. The *Pappomonas* and *Papposphaera* species show a range of central area structures (Young *et al.*, 2003) but most species show either an axial cross (e.g. *Papposphaera lepida*, Pl. 3, fig. A) or an axial cross plus additional elements. *Kataspiniifera* (Pl. 2) and *Pocillithus* (Pl. 3, fig. G) show similar axial crosses. *Picarola* has a rather broader and diagonally orientated cross-structure in the central area (Pl. 3, fig. D). Jordan & Chamberlain (1993) described the process-bearing *Vexillarius* coccoliths as having a single broad cross bar, but from the images they present this is not clear and it is possible that it has a cross-like structure similar to that of *Picarola*.
- iv Spine structure. The different genera have distinctly different central processes: simple spines in *Pocillithus* and *Kataspiniifera*; calyx-bearing spines in most *Pappomonas* and *Papposphaera* species; a bizarre curved process in *Picarola*, and flaring tower-spines in *Vexillarius*. In each case though these are hollow structures with rectangular (*Picarola*) or square cross-section (the other genera). Also each side of the spines is formed either of one long element or of a single series of quadrate elements.
- v Coccolith size. All these genera are characterized by production of small coccospheres (*c.* 5 µm excluding spines) and minute coccoliths (coccolith length typically 1–2 µm). Size is not a very reliable character but these are consistently minute and remarkably ornate for such small coccoliths.

This set of similarities separates these coccolithophores from other genera and strongly suggests affinity between them. Given the success of coccolithophore structure as an indicator of phylogenetic affinity (e.g. Sáez *et al.*, 2004), it seems reasonable to predict that the genera *Papposphaera*, *Pappomonas*, *Picarola*, *Pocillithus*, *Kataspiniifera* and *Vexillarius* are closely related and so should be included in the family Papposphaeraceae, the diagnosis of which is consequently slightly emended here.

The genus *Wigwamma* was also included by Young *et al.* (2003) in the narrow-rimmed murolith category. However, whilst this genus does produce very small coccoliths with narrow murolith rims, it does not appear to show any of the other characters of the group. Manton *et al.* (1977) have shown that *Wigwamma* coccoliths have a rather different rim-structure from that of the Papposphaeraceae, with two parallel cycles of similar-sized elements. *Wigwamma* coccoliths do typically show a cross-shaped central structure but this is formed of elements originating in the upper part of the rim and directed upwards to form a wigwam-like vaulted cross, as opposed to the flat central cross of the Papposphaeraceae. Finally, *Wigwamma* coccoliths do not have a central process. It is still possible that *Wigwamma* is related to the Papposphaeraceae, but the evidence for this



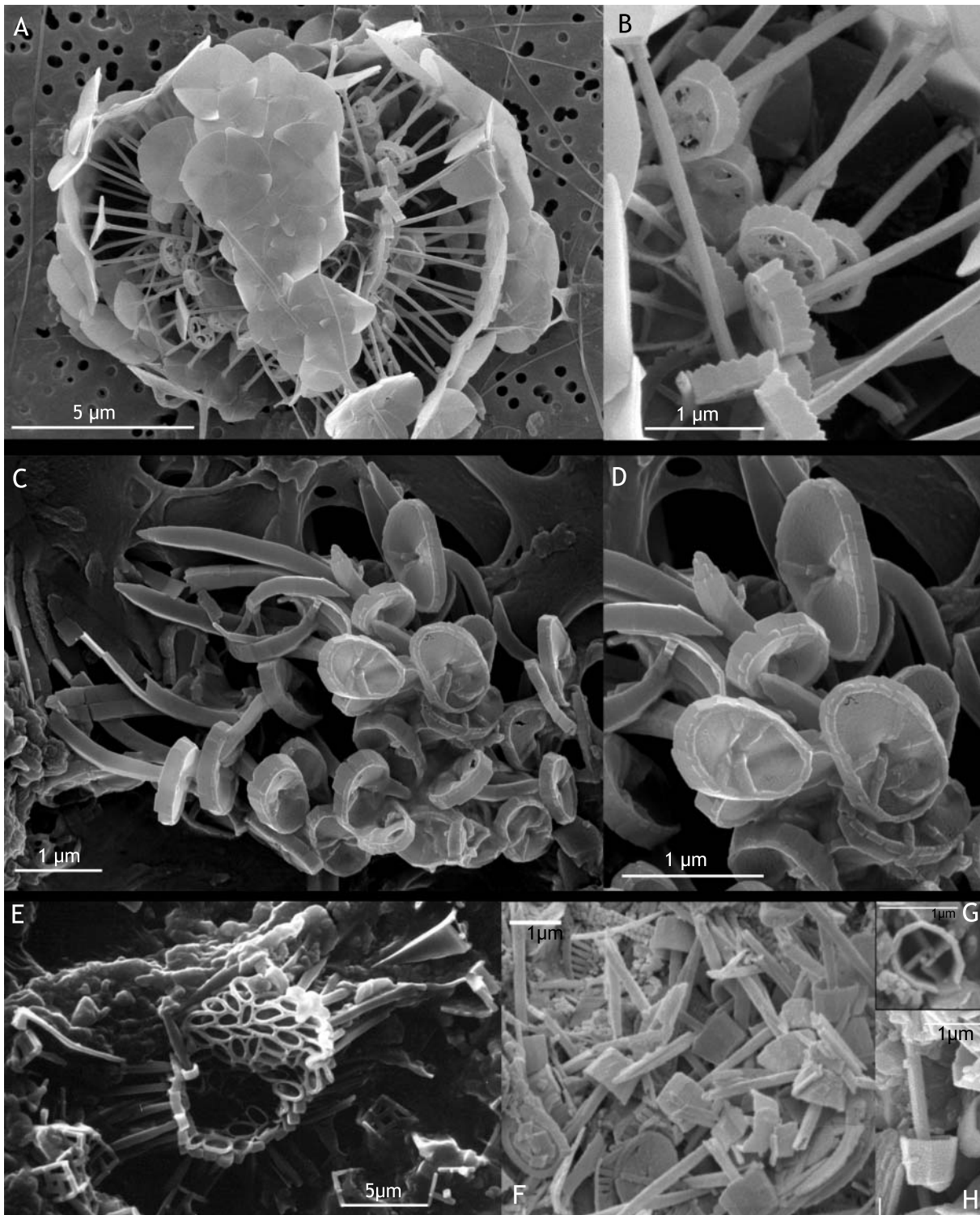

**Explanation of Plate 3.**

Comparative images of other species of Papposphaeraceae. **A, B.** *Papposphaera lepida*, from Alboran Sea, W. Mediterranean. Image NHM193-77. **C, D.** *Picarola margalefii*, from SE Pacific, cruise So-161, station 27, 51 m. Image BGR6134. **E.** *Vexillarius cancelifer*. Image VP71201, from Gulf of Mexico, Vita Pariente. **F–H.** *Pocillithus spinulifer*. Fossil collapsed coccosphere from the Upper Eocene of Tanzania and details of single coccoliths, scale bars 1 µm Images 12-26-141 and 12-23-214 (from Tom Dunkley-Jones, UCL).

	(i) Rim morphology: narrow-rimmed murooliths	(ii) Rim structure: wall cycle + basal cycle	(iii) Central area spanned by cross	(iv) Spine hollow, quadrate & formed of rectangular plates	(v) Coccolith length ( $\mu\text{m}$ )
<i>Pappomonas</i> / <i>Papposphaera</i>	Yes	Yes (Norris, 1983; Pl. 3, fig. B)	Most species	Yes	0.2–2
<i>Kataspiniifera</i>	Only spine-coccoliths	Yes (Pl. 2, fig F)	Yes	Yes	1.6–2.7
<i>Picarola</i>	Yes	Yes (Pl. 3, fig. D)	Yes (diagonal)	Yes (Pl. 3, figs C, D)	1–2
<i>Vexillarius</i>	Yes	Probably (Jordan & Chamberlain, 1993, pl. 1.2)	(not really known)	Yes (Jordan & Chamberlain, 1993, pl. 2.2)	c. 1
<i>Pocillithus</i> (fossil)	Yes	Yes (Bown, pers. comm.)	Yes	Yes	c. 0.8
<i>Wigwamma</i>	Yes	Yes, but somewhat different (Manton <i>et al.</i> , 1977)	Yes but vaulted	n/a	1–2

**Table 1.** Comparison of putatively related genera.

affinity is very weak. In conclusion, we believe *Wigwamma* should be retained in *incertae sedis* rather than transferred to the Papposphaeraceae.

2. *Prediscosphaera* and other Mesozoic coccolith genera. Numerous Mesozoic coccolith genera with long spines are superficially similar to *Kataspiniifera*. This suggests the intriguing possibility that it might be a ‘living fossil’, representative of a Mesozoic family which survived the Cretaceous/Palaeogene extinction event but was subsequently represented by species producing very small coccoliths with very low preservation potential. However, none of the Mesozoic coccoliths shows the same combination of a long quadrate spine without a calyx and a simple muroolith base with a non-imbricate structure. *Prediscosphaera* is probably the Mesozoic genus most similar to *Kataspiniifera* and is characterized by coccoliths with long hollow quadrate spines supported by a central-cross spanning a narrow rimmed circular or elliptical coccolith. However, in *Prediscosphaera* the rim has a placolith rather than a muroolith morphology and is always formed of exactly 16 segments; the radial bars are each formed of several elements; the spine bears a calyx and has a distinctive medial twist (e.g. Perch-Nielsen, 1985). *Kataspiniifera* does not show any of these features, so there is no good evidence to support the hypothesis that *Kataspiniifera* is directly related to *Prediscosphaera*. Similar arguments can be developed to reject hypotheses of relationships of *Kataspiniifera* with any other Mesozoic genera. So there is no reason to believe that *Kataspiniifera* is more closely related to Mesozoic taxa than to other modern coccolithophores.

3. *Rhabdosphaeraceae*, *Syracosphaerales*. Most dimorphic and/or spine-bearing coccolithophores in the modern nanoflora are members of the order Syracosphaerales (*sensu* Young *et al.*, 2003) and some of them produce coccospheres or coccoliths superficially similar to those of *Kataspiniifera* – e.g. *Acanthoica* (coccosphere similar), and *Syracosphaera nodosa* Kamptner (circum flagellar coccoliths bear spines).

Perhaps, most strikingly, *Acanthoica quattrosipina* produces spherical to ellipsoidal coccospheres in which only the circum-flagellar and antapical coccoliths bear spines, and in which the spines are much longer than the main body of the coccosphere (e.g. Young *et al.*, 2003). However, in the Syracosphaerales central area structures are radial lath cycles and/or continuous

covers of imbricate elements, simple central crosses are not known from the group. Moreover, the spines produced by Syracosphaerales coccoliths are formed of numerous small elements, usually arranged in a spiral, which is quite different to the mode of construction of the spine of this genus, and the other Papposphaeraceae. So, despite the superficial similarities in coccosphere form, there is no detailed morphological evidence for a close affinity with the Syracosphaerales.

4. *Chrysochromulina pringsheimii* Parke & Manton, 1962 and similar species. *Chrysochromulina* is a diverse genus of non-calcifying haptophytes including over 50 described species (Jordan *et al.*, 2004), and many more undescribed species (e.g. Marchant *et al.*, 2005). They do not produce coccoliths but have coverings of microfibrillar scales which like coccoliths are produced in golgi vesicles prior to exocytosis. These scale coverings are often polymorphic and can resemble coccospheres (Young, 1994). As noted by Manton & Oates (1983a), Manton (1986) and Young (1994), several species produce scale coverings with long spines at the apical and antapical poles, and so resemble coccolithophores such as *Acanthoica* and *Calciosolenia*. The resemblance to *Kataspiniifera baumannii* is much more striking, since the scales of *Chrysochromulina* and the coccoliths of *Kataspiniifera* are of similar sizes (1–2  $\mu\text{m}$ ), as are the cells. In some *Chrysochromulina* species (e.g. *C. pringsheimii* Parke & Manton, 1962 and *C. vexillifera* Manton & Oates, 1983a) the body scales bear spines supported by a cross-bar structure. Indeed, several colleagues who have worked on *Chrysochromulina* have commented on the similarity of *Kataspiniifera* and *Chrysochromulina* and suggested that it might be a calcified form of a previously described species. Similarly, Manton & Sutherland (1975) discussed the similarities of the *Papposphaera* and *Pappomonas* to spinose *Chrysochromulina* species, hinting that the Papposphaeraceae might have evolved directly from spinose *Chrysochromulina* species by evolution of calcification. The most awkward difference between Papposphaeraceae and *Chrysochromulina* for them was the presence of large calices on the tips of the spines in the Papposphaeraceae. They would certainly have regarded *Kataspiniifera* as an ideal intermediate and strong support for their hypothesis.

However, whilst the gross morphology of the organisms is similar there are significant morphological differences between the scales of the relevant *Chrysochromulina* species and the

*Kataspinifera* coccoliths. The *Chrysochromulina* scales have flat rather than elevated rims, vaulted rather than flat central crosses, and elongate rather than sub-spherical coccospheres. In addition, the scales of the large *Chrysochromulina* species resembling *Kataspinifera* are robust structures which are readily preserved in the SEM whereas on our specimens there is only a feeble organic membrane which shows no sign of a microfibrillar structure. So, although the similarities are certainly striking they are similarities of gross morphology rather than detailed structure.

More fundamentally, all molecular genetic data (Sáez *et al.*, 2004; de Vargas *et al.*, 2007; Edvardsen & Medlin, 2007; Medlin *et al.*, 2008) have supported the hypothesis that the coccolithophores and the Prymnesiales are discrete clades, with all *Chrysochromulina* falling within the Prymnesiales, except *C. parkeae* Green & Leadbeater, 1972 which does not resemble *Kataspinifera*. There are no molecular genetic data available for the Papposphaeraceae, but they share with the other coccolithophores not 'just' calcification, but heteromorphic life cycles producing holococcoliths and heterococcoliths in alternate life cycle stages (Thomsen *et al.*, 1991), both of which are highly distinctive biomineralization modes (Young *et al.*, 1999). Hence it is reasonable to predict that the Papposphaeraceae nest within the coccolithophore clade (Young *et al.*, 2005, Fig. 4). So, it is most likely that the superficial similarity between *Kataspinifera* and some *Chrysochromulina* species is a result of homoeomorphy than a reflection of a close evolutionary connection.

#### Spine formation

The spines of this species are one of the clearest examples documented of coccolith structures which are much longer (10–18 µm) than the cells (diameter 4–6 µm) with which they are associated. This is somewhat problematic, since there is abundant evidence that heterococcolith formation occurs intracellularly (see, for example, Young *et al.*, 1999). In the absence of observations on living cells it is impossible to determine how such long spines could have been formed. However, three basic possibilities are available. First, the coccoliths, or at least the spines, may have formed outside the cell, although this would be the first case known of extracellular calcification in a heterococcolith. Second, the spines may possibly have formed during a life-cycle stage when the cell was longer than it is in the sampled cells, or that the cell expanded temporarily to accommodate the coccolith. This type of explanation appears likely to account for long spine coccoliths in *Calciopappus* (Manton & Oates, 1983b; Young *et al.*, 2009) and for the very large coccoliths produced by *Scyphosphaera*, *Rhabdosphaera* and *Discosphaera* (Probert, pers. comm., from observations of live cells), but to form the very long spines of *Kataspinifera* in this way would require extreme elongation of the cell and so much more dynamic reorganization of the cell in response to calcification than usually occurs. Third, it is possible that the coccolith and its spine might form inside the cell but be exocytosed (i.e. released from the cell) before spine growth had been completed, so that spine growth continued inside the cell. Any of these possibilities would represent a significant departure from current knowledge of coccolith formation so the species would certainly be interesting to obtain in culture, or to observe as living cells.

#### Conclusions

*Kataspinifera baumannii* is an elegant new species and departs in form sufficiently from any known coccolithophore to warrant its own genus, *Kataspinifera*. The coccoliths it produces superficially resemble those of several Mesozoic genera, notably *Pre-discosphaera*. Likewise the coccospheres it produces resemble both the coccospheres of some coccolithophores, especially *Acanthoica*, and the scale cases of some species of *Chrysochromulina*. However, critical comparison of coccolith morphology and structure reveals that none of these apparent similarities is likely to reflect meaningful homologies but rather they are likely to be homoeomorphies, possibly indicating functional convergence. By contrast, comparison of the coccolith structure and morphology of this species with that shown by the Papposphaeraceae suggests that they are likely to be closely related. Moreover the additional genera *Vexillarius*, *Picarola* and *Pocillithus*, despite having disparate coccosphere morphologies, also show similarities in coccolith structure. Specifically all the five genera produce coccoliths with narrow murolith rims constructed of two cycles of alternating elements, with disjunct central area features typically including a central cross and hollow quadratesection spine. In consequence the family Papposphaeraceae is revised.

#### ACKNOWLEDGEMENTS

The authors thank the master and crew of research vessel *Somme* for their help in retrieving the samples. The technical support and dedicated co-operation of Sabine Stäger is gratefully acknowledged. Paul Bown and Tom Dunkley-Jones (UCL) kindly provided images of *Pocillithus*. Vita Pariente (University of Texas) provided an image of *Vexillarius*. Thanks go to Chantal Billard for providing the Latin diagnoses and valuable comments. Annelies Kleijne and Ric Jordan are thanked for their careful reviews of the original manuscript.

Manuscript received 29 March 2010

Manuscript accepted 17 August 2010

Scientific editing by Alan Lord

#### REFERENCES

- Andruleit, H., Rogalla, U. & Staeger, S. 2005. Living coccolithophores recorded during the onset of upwelling conditions off Oman in the western Arabian Sea. *Journal of Nanoplankton Research*, **27**(1): 1–14.
- Aubry, M.-P. & Kahn, A. 2006. New coccolithophores from the deep photic zone: Implications for evolutionary morphological convergence in the calcareous nanoplankton. *Micropaleontology*, **52**(5): 411–431.
- Bollmann, J., Cortes, M.Y., Kleijne, A., Østergaard, J.B. & Young, J.R. 2006. *Solisphaera* gen. nov. (Prymnesiophyceae), a new coccolithophore genus from the lower photic zone. *Phycologia*, **45**(4): 465–477.
- Bown, P.R., Dunkley-Jones, T., Lees, J.A. *et al.* 2008. A Paleogene calcareous microfossil Konservat-Lagerstätte from the Kilwa Group of coastal Tanzania. *Bulletin of the Geological Society of America*, **120**(1/2): 3–12.
- Cortés, M. 1998. *Coccolithophores at the Time-series Station ALOHA, Hawaii: population dynamics and ecology*. PhD thesis, University of Zürich, 198pp.
- Cortés, M.Y., Bollmann, J. & Thierstein, H.R. 2001. Coccolithophore ecology at the HOT station ALOHA Hawaii. *Deep-Sea Research. Part 2, Topical studies in oceanography*, **48**: 1957–1981.

- Cros, L. & Estrada, M. 2004. *Picarola margalefii*, gen. et sp. nov., a new planktonic coccolithophore from NW Mediterranean waters. *Scientia Marina*, **68**(suppl. 1): 243–248.
- Cros, L. & Fortuño, J.-M. 2002. Atlas of northwestern Mediterranean coccolithophores. *Scientia Marina*, **66**: 186.
- Dunkley-Jones, T., Bown, P.R. & Pearson, P. 2009. Exceptionally well preserved upper Eocene to lower Oligocene calcareous nannofossils (Prymnesiophycidae) from the Pande Formation (Kilwa Group), Tanzania. *Journal of Systematic Palaeontology*, **7**(4): 359–411.
- Edvardsen, B. & Medlin, L.K. 2007. Molecular systematics of Haptophyta. In: Brodie, J. & Lewis, J. (Eds), *Unravelling the algae the past, present, and future of algal systematics*. Systematics Association Special Volume Series, London, 183–196.
- Green, J.C. & Leadbeater, B.S.C. 1972. *Chrysochromulina parkeae* sp. nov. [Haptophyceae] a new species recorded from S.W. England and Norway. *Journal of the Marine Biological Association of the United Kingdom*, **52**: 469–474.
- Hagino, K. & Okada, H. 1998. *Gladiolithus striatus* sp. nov. (Prymnesiophyceae), a living coccolithophore from the lower photic zone of the Pacific Ocean. *Phycologia*, **37**(4): 246–250.
- Hagino, K., Okada, H. & Matsuoka, H. 2000. Spatial dynamics of coccolithophore assemblages in the Equatorial Western-Central Pacific Ocean. *Marine Micropaleontology*, **39**: 53–72.
- Hibberd, D.J. 1972. Chrysophyta: definition and interpretation. *British Phycological Journal*, **7**: 281.
- Hibberd, D.J. 1976. The ultrastructure and taxonomy of the Chrysophyceae and Prymnesiophyceae (Haptophyceae): a survey with some new observations on the ultrastructure of the Chrysophyceae. *Botanical Journal of the Linnean Society*, **72**: 55–80.
- Janin, M.-C. 1995. Biological affinities of the calcareous nannofossils: comparison with the organic scales secreted by living algae. In: Flores, J.A. & Sierro, F.J. (Eds), *5th INA Conference in Salamanca 1993 Proceedings*. Universidad de Salamanca, Salamanca, 67–86.
- Jordan, R.W. & Chamberlain, A.H.L. 1993. *Vexillarius cancellifer* gen. et sp. nov. and its possible affinities with other living coccolithophorids. In: Hamrsmid, B. & Young, J.R. (Eds), *INA 1991. Nannoplankton Research, biostratigraphy and paleobiology*. Quaternary coccoliths, INA 1991, Prague, 305–325.
- Jordan, R.W. & Young, J.R. 1990. Proposed changes to the classification system of living Coccolithophorids. *International Nannoplankton Association Newsletter*, **1**(12): 15–18.
- Jordan, R.W., Cros, L. & Young, J.R. 2004. A revised classification scheme for living Haptophytes. *Micropaleontology*, **50**(suppl. 1): 55–79.
- Jordan, R.W., Knappertsbusch, M., Simpson, W.R. & Chamberlain, A.H.L. 1991. *Turrilithus latericioides* gen. et sp. nov., a new coccolithophorid from the deep photic zone. *British Phycological Journal*, **26**: 175–183.
- Manton, I. 1986. Functional parallels between calcified and uncalcified periplasts. In: Leadbeater, B.S.C. & Riding, J.B. (Eds), *Biom mineralization in Lower Plants and Animals*. Systematics Association Special Volume, London, 157–172.
- Manton, I. & Oates, K. 1975. Fine-structural observations on *Papposphaera* Tangen from the Southern Hemisphere and on *Pappomonas* gen. nov. from South Africa and Greenland. *British Phycological Journal*, **10**(1): 93–109.
- Manton, I. & Oates, K. 1983a. Nanoplankton from the Galapagos Islands: *Chrysochromulina vexillifera* sp. nov. (Haptophyceae = Prymnesiophyceae), a species with semivestigial body spines. *Botanica Marina*, **16**: 517–525.
- Manton, I. & Oates, K. 1983b. Nanoplankton from the Galapagos Islands: Two genera of spectacular coccolithophorids (*Ophiaster* and *Calciopappus*) with special emphasis on unmineralized periplast components. *Philosophical Transactions of the Royal Society of London (B)*, **300**: 435–462.
- Manton, I. & Sutherland, J. 1975. Further observations on the genus *Pappomonas* Manton et Oates with special reference to *P. virgulosa* sp. nov. from West Greenland. *British Phycological Journal*, **10**: 377–385.
- Manton, I., Sutherland, J. & McCully, M. 1976. Fine structural observations on coccolithophorids from South Alaska in the genera *Papposphaera* Tangen and *Pappomonas* Manton and Oates. *British Phycological Journal*, **11**: 225–234.
- Manton, I., Sutherland, J. & Oates, K. 1977. Arctic coccolithophorids: *Wigwamma arctica* gen. et sp. nov. from Greenland and Arctic Canada; *W. annulifera* sp. nov. from South Africa and S. Alaska and *Calciarcus alaskensis* gen. et sp. nov. from S. Alaska. *Proceedings of the Royal Society of London*, **197**(1127): 145–168.
- Marchant, H.J., Scott, F.J. & Davidson, A.T. 2005. Haptophytes: Order Prymnesiales. In: Scott, F.J. & Marchant, H.J. (Eds), *Antarctic Marine Protists*. Australian Biological Resources Study, Canberra, 255–275.
- Medlin, L.K., Sáez, A.G. & Young, J.R. 2008. A molecular clock for coccolithophores and implications for selectivity of phytoplankton extinctions across the K/T boundary. *Marine Micropaleontology*, **67**(1–2): 69–86.
- Norris, R.E. 1983. The family position of *Papposphaera* Tangen and *Pappomonas* Manton & Oates (Prymnesiophyceae) with records from the Indian Ocean. *Phycologia*, **22**(2): 161–169.
- Okada, H. & Honjo, S. 1973. The distribution of oceanic coccolithophorids in the Pacific. *Deep-Sea Research*, **20**: 355–374.
- Okada, H. & McIntyre, A. 1979. Seasonal distribution of modern coccolithophores in the Western North Atlantic Ocean. *Marine Biology*, **54**: 319–328.
- Parke, M. & Manton, I. 1962. Studies on marine flagellates. VI. *Chrysochromulina pringsheimii* sp. nov. *Journal of the Marine Biological Association of the United Kingdom*, **42**: 391–404.
- Perch-Nielsen, K. 1985. Mesozoic calcareous nannofossils. In: Bolli, H.M., Saunders, J.B. & Perch-Nielsen, K. (Eds), *Plankton Stratigraphy*. Cambridge University Press, Cambridge, 329–426.
- Sáez, A.G., Probert, I., Young, J.R., Edvardsen, B., Wenche, E. & Medlin, L.K. 2004. A review of the phylogeny of the Haptophyta. In: Thierstein, H.R. & Young, J.R. (Eds), *Coccolithophores – from molecular processes to global impact*. Springer, 251–270.
- Takano, Y., Hagino, K., Tanaka, Y., Horiguchi, T. & Okada, H. 2006. Phylogenetic affinities of an enigmatic nanoplankton, *Braarudosphaera bigelowii* based on the SSU rDNA sequences. *Marine Micropaleontology*, **60**: 145–156.
- Tangen, K. 1972. *Papposphaera lepida*, gen. nov. n. sp., a new marine coccolithophorid from Norwegian coastal waters. *Norwegian Journal of Botany*, **19**: 171–178.
- Thomsen, H.A., Buck, K.R., Coale, S.L., Garrison, D.L. & Gowing, M.M. 1988. Nanoplanktonic coccolithophorids (Prymnesiophyceae, Haptophyceae) from the Weddell Sea, Antarctica. *Nordic Journal of Botany*, **8**: 419–436.
- Thomsen, H.A., Ostergaard, J.B. & Hansen, L.E. 1991. Heteromorphic life histories in Arctic coccolithophorids (Prymnesiophyceae). *Journal of Phycology*, **27**: 634–642.
- de Vargas, C., Aubry, M.-P., Probert, I. & Young, J.R. 2007. Origin and evolution of coccolithophores: From coastal hunters to oceanic farmers. In: Falkowski, P.G. & Knoll, A.H. (Eds), *Evolution of Primary Producers in the Sea*. Elsevier, Boston, 251–285.
- Wiedicke, M. & 21, others. 2002. *Cruise Report Sonne Cruise SO-161-5, SPOC, Subduction Processes off Chile. BGR Reports 11241/02*, Bundesanstalt fuer Geowissenschaften und Rohstoffe, Hannover.
- Young, J.R. 1994. Functions of coccoliths. In: Winter, A. & Siesser, W.G. (Eds), *Coccolithophores*. Cambridge University Press, Cambridge, 63–82.
- Young, J.R. 2008. *Scyphosphaera porosa* Kamptner 1967 rediscovered in the plankton. *Journal of Nannoplankton Research*, **30**(1): 35–38.
- Young, J.R. & Andruleit, H. 2006. *Navilithus altivelum*: a remarkable new genus and species of deep photic coccolithophores. *Journal of Micropalaeontology*, **25**(2): 141–152.
- Young, J.R., Andruleit, H. & Probert, I. 2009. Coccolith function and morphogenesis, insights from appendage-bearing coccolithophores of the family Syracosphaeraceae (Haptophyta). *Journal of Phycology*, **45**: 213–226.
- Young, J.R., Bergen, J.A., Bown, P.R. et al. 1997. Guidelines for coccolith and calcareous nannofossil terminology. *Palaeontology*, **40**: 875–912.

*Kataspinifera*: a new deep photic coccolithophore

Young, J.R., Davis, S.A., Bown, P.R. & Mann, S. 1999. Coccolith ultrastructure and biomineralisation. *Journal of Structural Biology*, **126**: 195–215.

Young, J.R., Geisen, M., Cros, L., Kleijne, A., Probert, I. & Ostergaard, J.B. 2003. A guide to extant coccolithophore taxonomy. *Journal of Nannoplankton Research, Special Issue*, **1**: 1–132.

Young, J.R., Geisen, M. & Probert, I. 2005. A review of selected aspects of coccolithophore biology with implications for palaeobiodiversity estimation. *Micropaleontology*, **51**(4): 267–288.



## From the Geological Society Publishing House

For full details see the Online Bookshop: [www.geolsoc.org.uk/bookshop](http://www.geolsoc.org.uk/bookshop)

**NEW**



- ISBN: 978-1-86239-303-5
- August 2010
- Pages tbc • Hardback
- Prices: tbc

Online bookshop code: SP338

### • Special Publication 338

## The Evolving Continents: Understanding the Processes of Continental Growth

*Edited by T. M. Kusky, M.-G. Zhai and W. Xiao*

This Special Publication of the Geological Society of London, *The Evolving Continents: Understanding Processes of Continental Growth*, was written to honour the career of Brian F. Windley, who has been hugely influential in helping to achieve our current understanding of the evolution of the continental crust, and who has inspired many students and scientist to pursue studies on the evolution of the continents. Brian has studied processes of continental formation and evolution on most continents and of all ages, and has educated and inspired two generations of geologists to undertake careers in studies of continental evolution. The volume is organized into six sections, including: oceanic and island arc systems and continental growth; tectonics of accretionary orogens and continental growth; growth and stabilization of continental crust: collisions and intraplate processes; Precambrian tectonics and the birth of continents; and active tectonics and geomorphology of continental collision and growth zones.

**NEW**



- ISBN: 978-1-86239-300-4
- July 2010
- Pages tbc • Hardback
- Prices: tbc

Online bookshop code: SP335

### • Special Publication 335

## Continental Tectonics and Mountain Building: The Legacy of Peach and Horne

*Edited by R. D. Law, R. W. H. Butler, R. E. Holdsworth, M. Krabbendam and R. A. Strachan*

The world's mountain ranges are the clearest manifestations of long-term deformation of the continental crust. As such they have attracted geological investigations for centuries. Throughout this long history of research a few keynote publications stand out. One of the most important is the Geological Survey's 1907 Memoir on *The Geological Structure of the North-West Highlands of Scotland*. The Memoir summarized some of the Geological Survey's finest work, and outlined many of the principles of field-based structural and tectonic analysis that have subsequently guided generations of geologists working in other mountain belts, both ancient and modern. The thematic set of 32 papers in this Special Publication celebrate the 100th anniversary of the 1907 Memoir by placing the original findings in both historical and modern contexts, and juxtaposing them against present-day studies of deformation processes operating not only in the NW Highlands, but also in other mountain belts.

**NEW**



- ISBN: 978-1-86239-295-3
- April 2010
- 240 pages • Hardback
- Prices:

List: £85.00/US\$170.00

GSL: £42.50/US\$85.00

Other qualifying societies:

£51.00/US\$102.00 (Cat no tbc)

Online bookshop code: SP332

### • Special Publication 332

## Advances in Interpretation of Geological Processes: Refinement of Multi-scale Data and Integration in Numerical Modelling

*Edited by M. I. Spalla, A. M. Marotta and G. Gosso*

Iterative comparison of analytical results and natural observations with predictions of numerical models improves interpretation of geological processes. Further refinements derive from wide-angle comparison of results from various scales of study. In this volume, advances from field, laboratory and modelling approaches to tectonic evolution - from the lithosphere to the rock scale - are compared. Constructive use is made of apparently discrepant or non-consistent results from analytical or methodological approaches in processing field or laboratory data, P-T estimates, absolute or relative age determinations of tectonic events, tectonic unit size in crustal-scale deformation, grain-scale deformation processes, various modelling approaches, and numerical techniques.

Advances in geodynamic modelling critically depend on new insights into grain- and subgrain-scale deformation processes. Conversely, quantitative models help to identify which rheological laws and parameters exert the strongest control on multi-scale deformation up to lithosphere and upper mantle scale.

**NEW**



- ISBN: 978-1-86239-293-9
- March 2010
- 376 pages • Hardback
- List: £95.00/US\$190.00
- GSL: £47.50/US\$95.00

Other qualifying societies:

£57.00/US\$114.00 (Cat no tbc)

Online bookshop code: SP330

### • Special Publication 330

## Tectonic and Stratigraphic Evolution of Zagros and Makran during the Mesozoic-Cenozoic

*Edited by P. Leturmy and C. Robin*

The Zagros fold-thrust belt (ZFTB) extends from Turkey to the Hormuz Strait, resulting from the collision of the Arabian and Eurasian plates during Cenozoic times, and separates the Arabian platform from the large plateaux of central Iran. To the east a pronounced syntaxis marks the transition between the Zagros collision belt and the Makran accretionary wedge. In the ZFTB, the Proterozoic to Recent stratigraphic succession pile is involved in huge folds, and offers the opportunity to study the stratigraphic and tectonic evolution of the Palaeo-Tethyan margin.

Few recent data were widely available on the southern Tethys margin preserved in the Zagros Mountains. The Middle East Basins Evolution (MEBE) program was an excellent opportunity to go back to the field and to collect new data to better constrain the evolution of this margin. In this volume the structure of the Zagros Mountains is explored through different scales and using different methodologies.

Order from:  
[www.geolsoc.org.uk/bookshop](http://www.geolsoc.org.uk/bookshop)



The Geological Society's Lyell Collection: journals, Special Publications and books online. For more information visit [www.geolsoc.org.uk/LyellCollection](http://www.geolsoc.org.uk/LyellCollection)